

T4J

RUBINETTO DI INTERCETTAZIONE TOP ENTRY

Scheda tecnica
MCTW013.00 - 05/2019



- T4J è un rubinetto di intercettazione
- Passaggio totale, a norma EN 806-2
- Intercettazioni TOP-ENTRY® estraibili
- Corpo monoblocco
- Adatte ad uso domestico e industriale con sensore della temperatura e/o dado girevole per attacco contatore
- Finitura cromata



Materiale		
Corpo	Sfera	Comando
Ottone CW617	Ottone CW617 cromato	Alluminio AL EN-AB44100

SPECIFICHE TECNICHE

Conessioni	Norme di riferimento	Pressione di esercizio	Temperatura di esercizio	Campo di impiego
Filettata F.	DIN EN 13828 (PN10) DVGW W 570-1	PN40 [40 bar]	0°C +150 °C	Impianti di distribuzione idrici, riscaldamento, pneumatici, petrolchimici, petroliferi. Adatta per fluidi non aggressivi e vuoto.

VERSIONI E CODICI

Valvola con attacco sonda versione filettata F/F

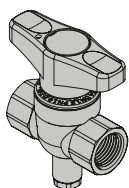

Comando maniglia

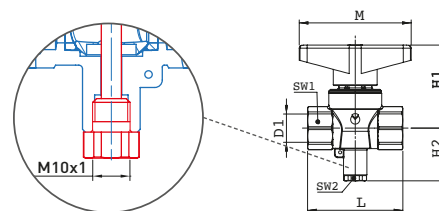

Codice	DN	D1 EN-10226-1	L	H1	H2	M	SW1	SW2	Conf.
T40413J0	15	Rp1/2"	63	55	32,5	74	27	14	45
T40414J0	20	Rp3/4"	73	58	32,5	74	32	14	35
T40415J0	25	Rp1"	73	88	35	94	41	14	20

TECO Srl
Via Sandro Pertini, 39/41 - Zona industriale Noccole, 25050 Provaglio d'Iseo (BS)

+39 030 6850510 | +39 030 6850555
info@tecosrl.it | www.tecosrl.it



Valvola con attacco sonda versione filettata F/F

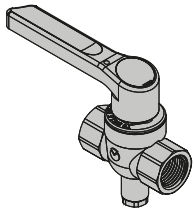

Comando leva

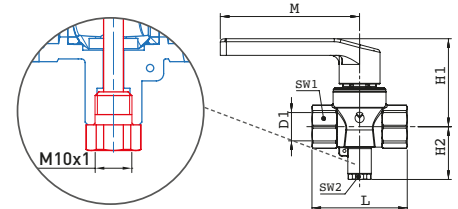

Codice	DN	D1 EN-10226-1	L	H1	H2	M	SW1	SW2	Conf.
T40406JO	32	Rp1"1/4	100	76	37,5	124	50	14	15
T40407JO	40	Rp1"1/2	110	82	41	147	55	14	10
T40408JO	50	Rp2"	131	88	48,4	147	70	14	5

Valvola diritta con attacco sonda versione filettata/dado girevole

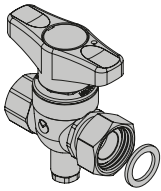

Comando maniglia

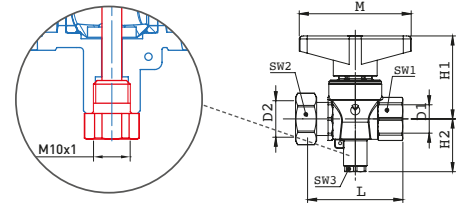

Codice	DN	D1 EN-10226-1	D2 EN-228-1	L	H1	H2	M	SW1	SW2	SW3	Conf.
T40413JOR	15	Rp1/2"	G3/4"	71	55	32,5	74	27	30	14	45
T40414JOR	20	Rp3/4"	G1"	73	58	32,5	74	32	37	14	35

Valvola diritta versione filettata/dado girevole

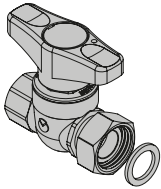

Comando maniglia

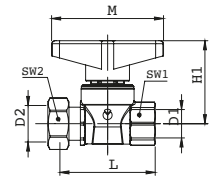

Codice	DN	D1	D2	L	H1	M	SW1	SW2	Conf.
T4041300R	15	Rp1/2"	G3/4"	82,5	55	74	27	30	45
T4041400R	20	Rp3/4"	G1"	84	58	74	32	37	35

Valvola diritta versione filettata mx (ISO 228) / dado girevole

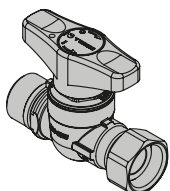

Comando maniglia

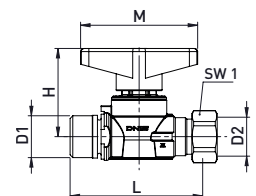

Codice	DN	D1	D2	M	L	H	SW1	Conf.
T403910400	15	Rp1/2"	G3/4"	74	84	55	30	10

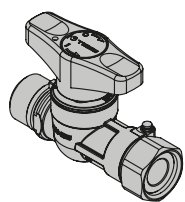

Comando maniglia

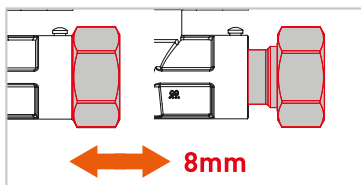

i Il sistema FASTEC EX permette un'escursione di 8 mm facilitando il collegamento dei gruppi di contabilizzazione.

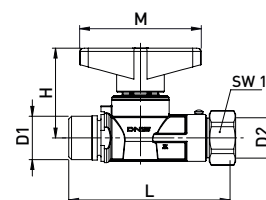

Codice	DN	D1	D2	M	L	H	SW1	Conf.
T403910200	15	Rp1/2"	G3/4"	74	98+8*	55	30	10

FUNZIONAMENTO E TECNOLOGIE

Manutenzione TECO CONTROL

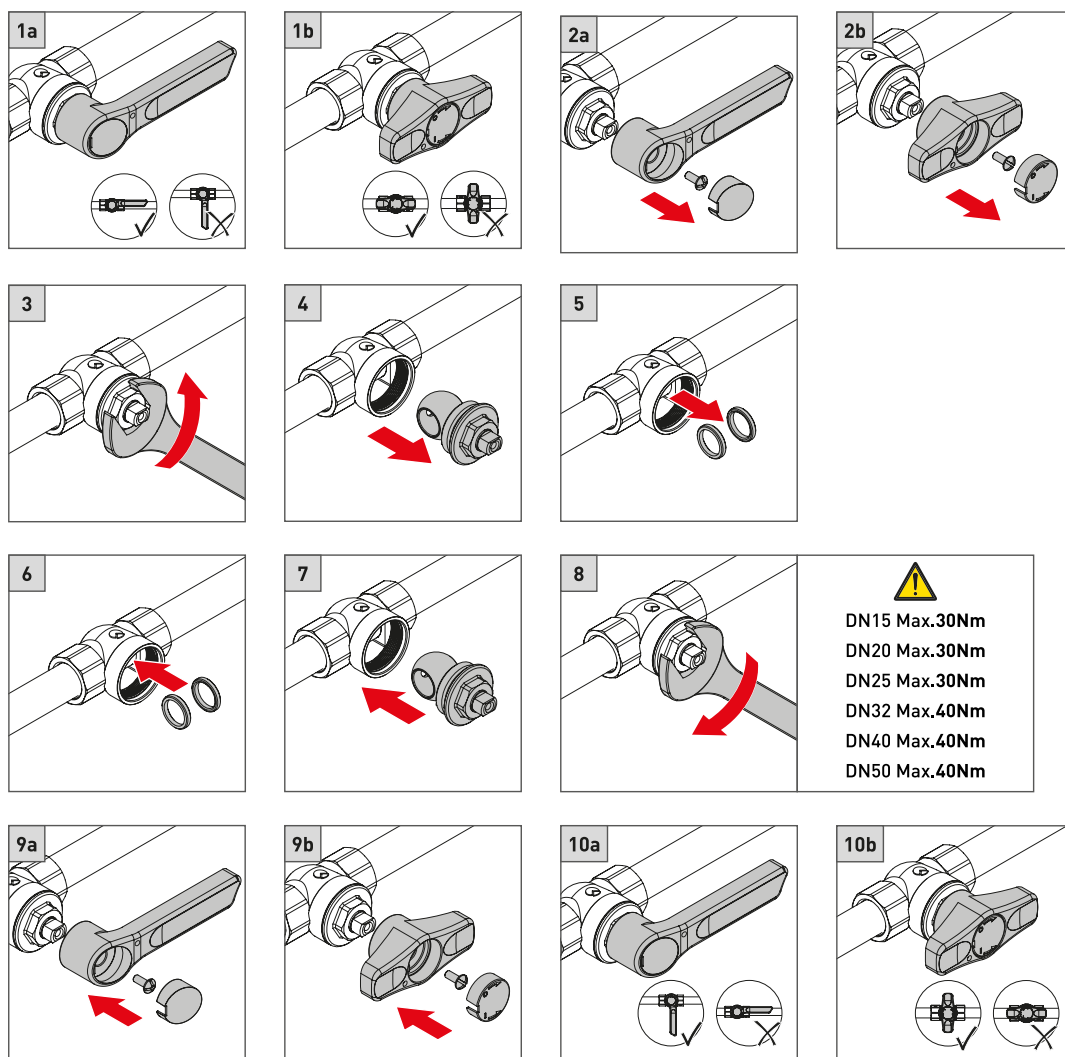

⚠
 DN15 Max.30Nm
 DN20 Max.30Nm
 DN25 Max.30Nm
 DN32 Max.40Nm
 DN40 Max.40Nm
 DN50 Max.40Nm

INSTALLAZIONI E APPLICAZIONI

Impianti di contabilizzazione

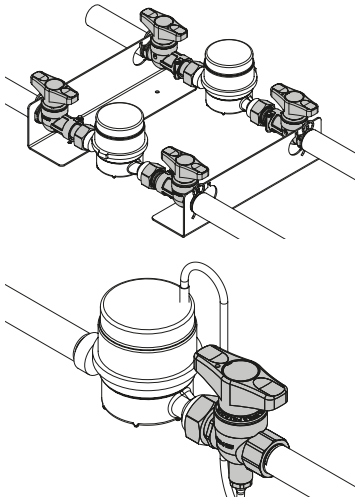

Temperatura / Pressione

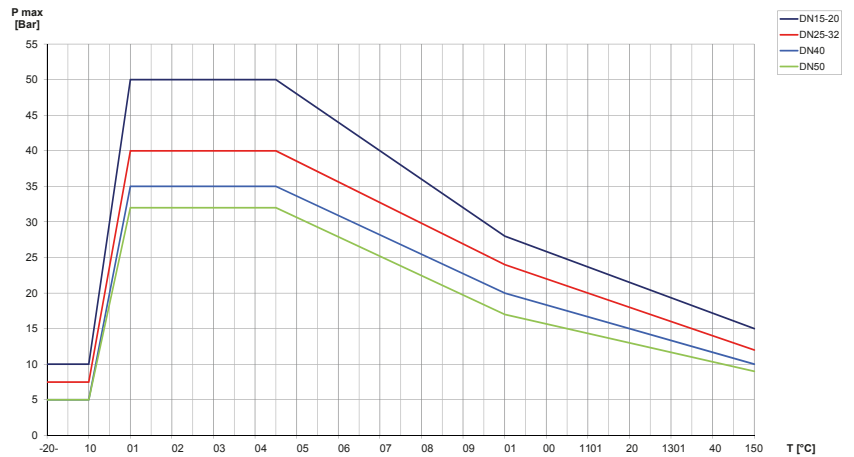

RICAMBI

Teco control

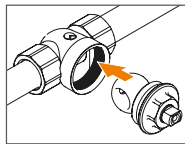

Codice	DN	Conf.
KRLE040100	15	20
KRLE040200	20	15
KRLE040300	25	10
KRLE040400	32	5
KRLE040500	40	5
KRLE040600	50	2

Kit guarnizioni

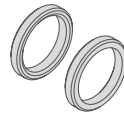

Codice	DN	Conf.
5004000130	15	20
5004000140	20	15
5004000150	25	10
5004000160	32	10
5004000170	40	10
5004000180	50	10

Maniglia

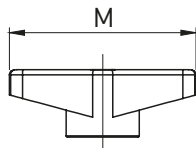
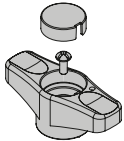

Codice	DN	M	Conf.
KRMN041100	15-20	74	20
KRMN040300	25	94	10

Leva

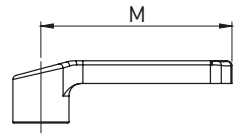
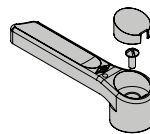

Codice	DN	M	Conf.
KRLE041100	15-20	92	20
KRLE041200	25-32	124	20
KRLE041300	40-50	147	10

TESTI DI CAPITOLATO

T4J: Rubinetto d'intercettazione

Rubinetto d'intercettazione a sfera estraibile Top Entry con passaggio totale, Corpo monoblocco predisposto con sensore della temperatura e/o dado girevole per attacco contatore. Conforme alla norma UNI EN 13828. Sfera in Ottone cromato con foro anti ristagno. Accessori a leva o maniglia in Alluminio verniciato. Manovra a 90 gradi. range di Temperatura 0-150 (picco) °C.

Pressione massima PN 40 bar.



TECO Srl
Via Sandro Pertini, 39/41 - Zona industriale Noccole, 25050 Provaglio d'Iseo (BS)

+39 030 6850510 | +39 030 6850555
info@tecosrl.it | www.tecosrl.it

